





NOTES: UNLESS OTHERWISE SPECIFIED

1. MATERIALS AND COMPONENTS ARE RoHS/REACH COMPLIANT.
2. CONNECTORS MEET THE REQUIREMENTS OF ANSI/TIA 568-C.3
3. 100% TESTED FOR OPTICAL PERFORMANCE, END FACE CRITERIA AND CLEANLINESS.
4. CABLE ASSEMBLIES ARE MANUFACTURED TO C ENTERPRISES STANDARDS.
5. STANDARDS AND SPECIFICATIONS AVAILABLE UPON REQUEST.
6. NOT ALL FIBER LEGS ARE SHOWN DO TO SPACE CONSTRAINT.
7. STAGGERED END WITH PULLING EYE
 - 7.1. SUBUNITS
 - 7.1.1. SUBUNITS STAGGERED INCREASING BY 6 INCH INCREMENTS.
 - 7.1.2. SHORTEST SUBUNIT IS MEASURED 8 INCHES FROM INNER CABLE JACKET BREAKOUT. 
 - 7.2. CONNECTORS
 - 7.2.1. CONNECTOR PAIRS STAGGERED BY 1 INCH INCREMENTS.
 - 7.2.2. PAIRS STAGGER ALTERNATE BY INCREASING AND DECREASING FROM DEFINED BREAKOUT LENGTH.
 - 7.2.3. PAIRS 1-2 LONGEST: 27 INCHES. PAIRS 11-12 SHORTEST: 22 INCHES.

-  HEAT SHRINK FOR STRAIN RELIEF
-  SPIRAL WRAP FOR STRAIN RELIEF
-  HEAT SHRINK FOR CABLE PROTECTION

REV	ECR	DESCRIPTION	BY	DATE	CHECKED
A	-	INITIAL RELEASE	K.T.	09/27/2017	A.J.

VIEW A
CROSS SECTION
NOT TO SCALE

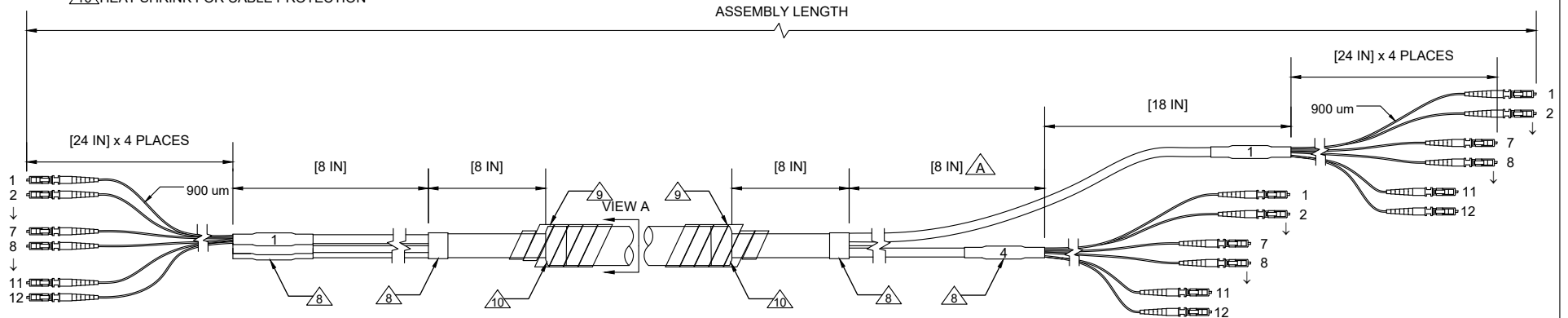
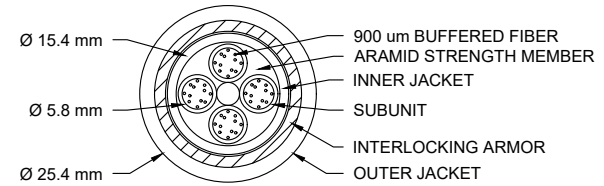

EXAMPLE OF PULLING EYE



BILL OF MATERIALS

ITEM	QTY	COMPONENT
4	1	SINGLE-MODE APC TEST REPORT
3	1	PULLING EYE: 48 FIBERS
2	AR	SINGLE-MODE OS2 24 FIBER OFCP TIGHT-BUFFER ARMORED CABLE; YELLOW: PERFORMA
1	144	LC-UNCLIPPED APC POLISH CONNECTOR; GREEN HOUSING, GREEN BOOT: PERFORMA

APC TEST LIMITS
AT 1310 nm

MAX. I.L.	TYP. I.L.	MIN. R.L.	TYP. R.L.
≤0.50dB	0.20dB	≥65dB	68dB

DESCRIPTION: LC-UNCLIPPED/ LC-UNCLIPPED APC POLISH x 48-FIBER OS2 OFCP ARMORED CABLE, 900 um BREAKOUT, TEST REPORT, PULLING EYE w/STAGGERED CONNECTORS			
DRAWN BY:	K. THOMAS	09/27/2017	 <p>C ENTERPRISES 2445 CADES WAY VISTA CA 92081 760-599-5111</p>
APVD BY:	A. JENSEN	09/27/2017	
DIMENSIONS: METRIC [IMPERIAL]		TITLE: LC/LC APC x48-FIBER SM OFCP	
PROPRIETARY AND CONFIDENTIAL		SIZE: A	DWG. NO.: SAPA48LBLB9RPPX
THIS DOCUMENT CONTAINS PROPRIETARY INFORMATION OF C ENTERPRISES. NOT TO BE USED, COPIED, OR DISCLOSED WITHOUT WRITTEN PERMISSION. ALL RIGHTS RESERVED.		SCALE: NOT TO SCALE	REV: A
		SHEET 1 OF 1	